

SIDE VIEW

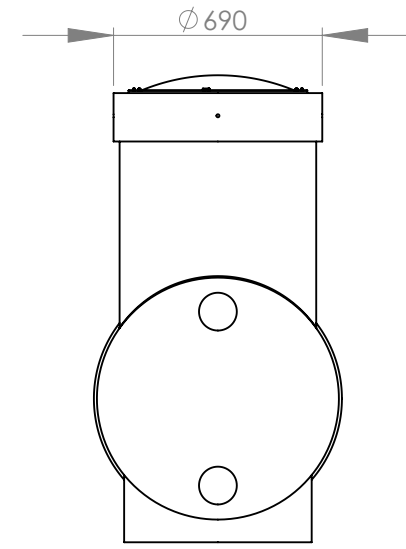

END VIEW



PLAN VIEW

CAPACITY: 1,500 Litres

	NAME	DATE
DRAWN	D.I.B.	3 AUGUST 2011
CHK'D		
APPV'D		
DIMENSIONS OF ROTO MOULDED PARTS ARE APPROX DUE TO VARIATIONS IN THE MANUFACTURING PROCESS		
DO NOT SCALE DRAWING		
Copyright Bailey Tanks Limited 2011		
WEIGHT: 140 KG		

Bailey Tanks Limited
 36 Ash Road, Wiri, Auckland, New Zealand
 Tel: + 64 9 2627070 Fax: +64 9 2627071
 Web: www.baileytanks.com
 Email: info@baileytanks.com



DWG NO.

SUB800D.1500

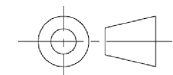

A4

SCALE: 1:25

SHEET 1 OF 1

REVISION